

CG	COG	ITO	Light Guide Plate	OLED	LOGO
1. 邊緣缺損	1. CF 邊破	1. 蝕刻不良	1. 冷料	1. 劃痕	1. 刮傷
2. 功能孔缺損	2. TFT 邊破	2. 蝕刻斷裂	2. 光點	2. 印刷不良	2. 汙染物
3. 倒角異常	3. CF 角破		3. 混料	3. 髒汙	3. 條紋
4. 刮傷	4. TFT 角破		4. 暗影	4. 異物	4. 針孔
5. 黑/白點 (紫傷)	5. 裂紋		5. 摩擦痕	5. 正面邊崩	5. 糊狀的邊緣
6. 針孔	6. 銀膠不良		6. 噴油	6. 缺藍色保護貼	6. 鏽斑
7. 印刷不良	7. 邊緣凸起		7. 紅點	7. 凹點	7. 橘皮
8. 髒汙(灰塵)	8. 膜翹		8. 黑點	8. IC 腳缺陷	8. 凹痕
9. CG 尺寸	9. 偏光板刮傷		9. 暗線	9. 溢膠	9. Haze 霧度
10. 鍍膜不良			10. 卡料	10. 缺紅色保護貼	
11. 透光率			11. 異物	11. 背面邊崩	
12. IR 孔			12. 黃點		
13. 翹曲度			13. 崩角		
14. CG 厚度			14. 牽絲		
15. AG Gloss 反射率			15. 氣泡		
16. AG 陰影					
17. 凹痕(AG)					
18. 表層切削(AG)					
19. 背層切削(AG)					
20. 刮傷(AG)					
21. 裂紋(AG)					
22. 原材刮傷					
23. 點狀不良(AG)					

1 邊緣缺損

2014-7-18	7" (CG)	Go to TOP

IICc

2 功能孔缺損

2014-7-18

7" (CG)

[Go to TOP](#)

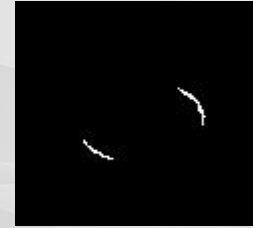
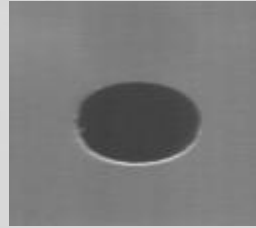

IICc

3 倒角異常

2012-10-8

14 × 16" (CG)

[Go to TOP](#)



IICc

4 刮傷

2014-7-18

7" (CG)

[Go to TOP](#)



II Cc

5 黒/白点 (紫傷)

2014-7-18

7" (CG)

[Go to TOP](#)

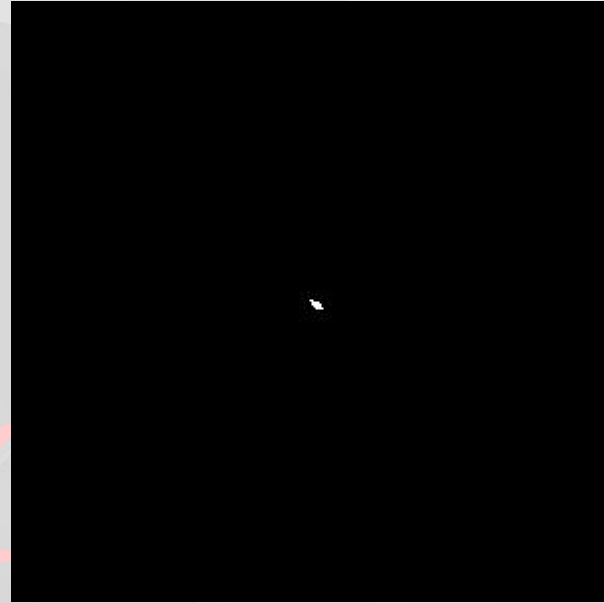
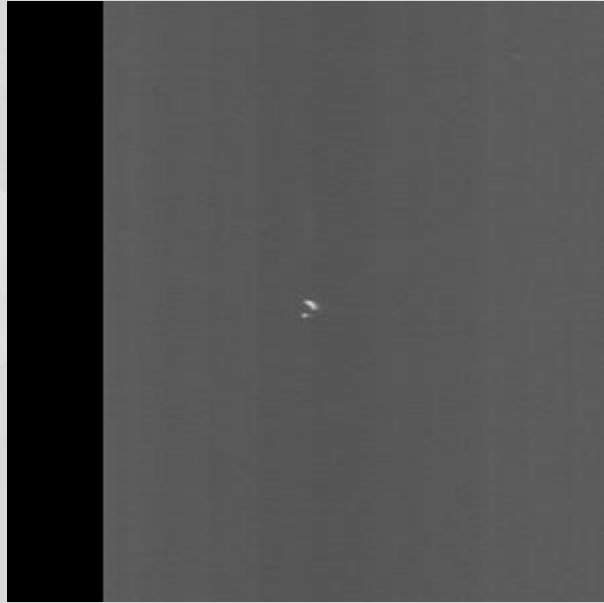

6 針孔

2014-7-18

7" (CG)

[Go to TOP](#)

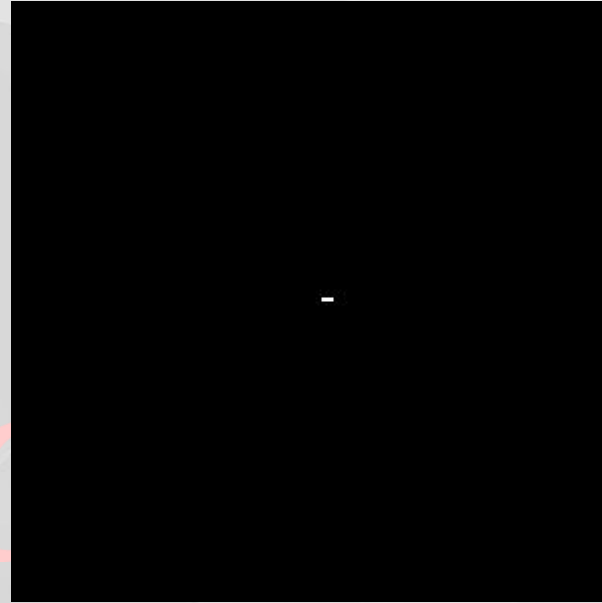
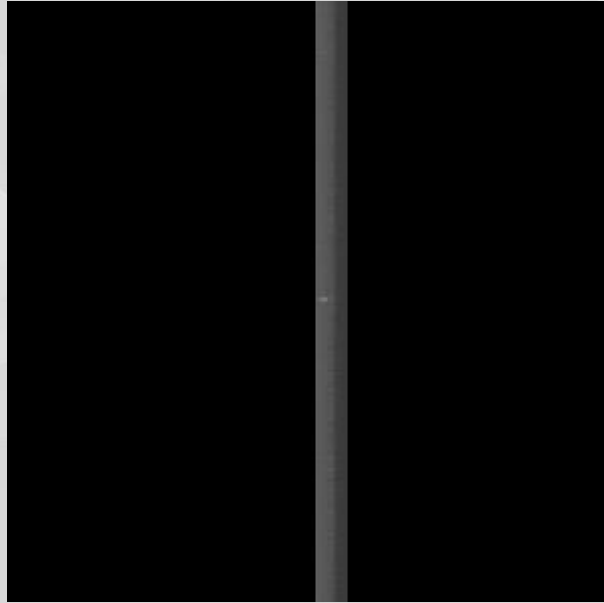

7 印刷不良

2014-7-18

7" (CG)

[Go to TOP](#)

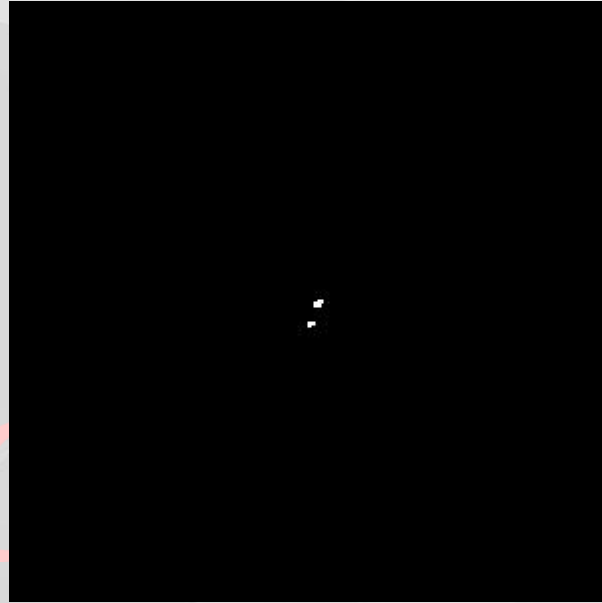
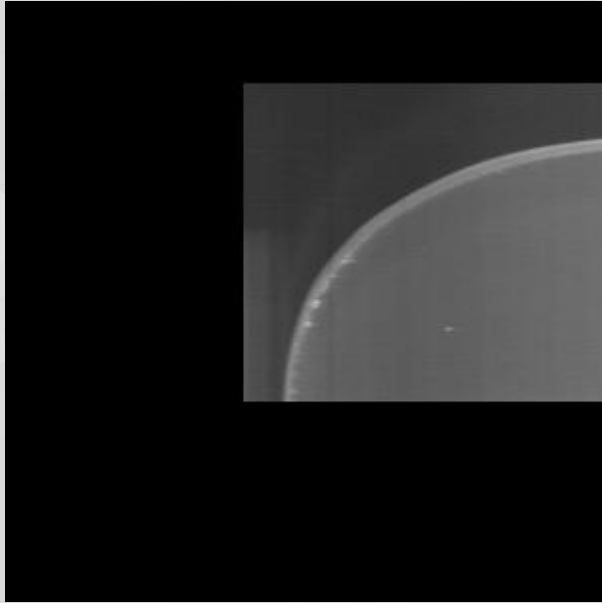

8 脏污(灰尘)

2014-7-18

7" (CG)

[Go to TOP](#)

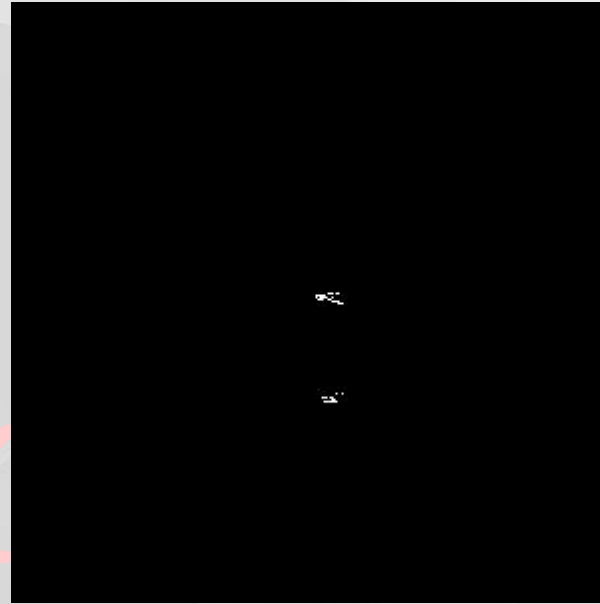
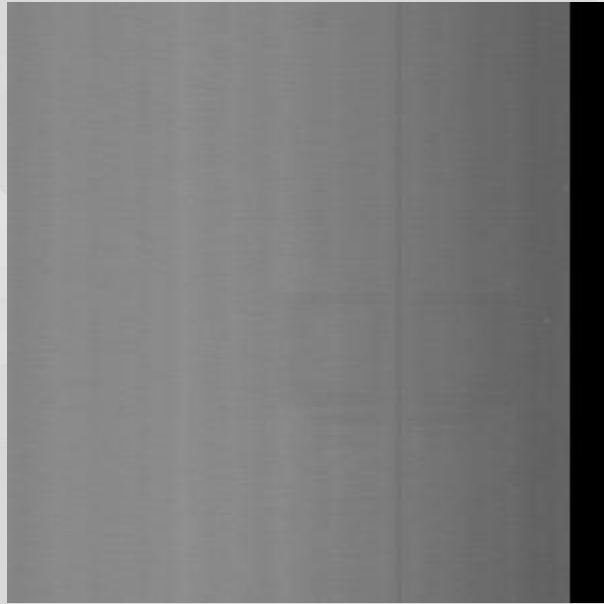

9 尺寸 Size

2017-1-11

207.96 × 141 × 2 mm

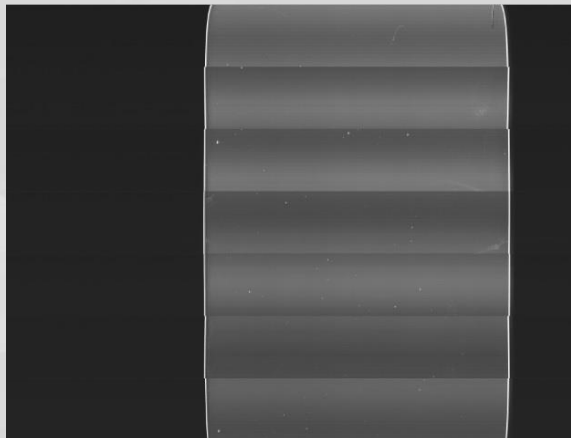

[Go to TOP](#)



Pixels	Width(mm)
3398	141.57

IICc

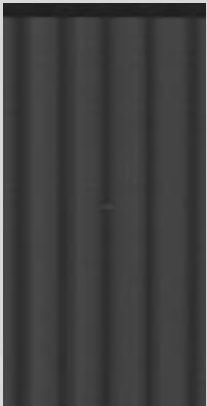
10 鍍膜不良

2017-1-17	12.3" (CG)	Go to TOP
		

HCc

11 透光率

2017-1-11

207.96 × 141 × 2 mm

[Go to TOP](#)

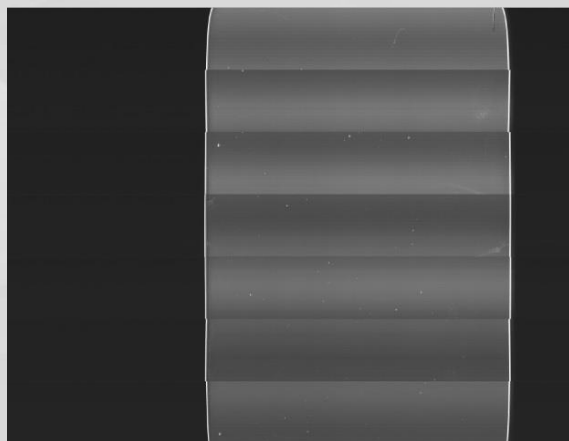

Transmission

115.7769

ICc

12 IR 孔

2014-7-18

7”(CG)

[Go to TOP](#)

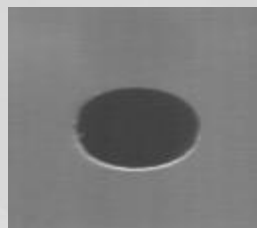

Transmission

114.7266

HCc

13 翹曲度

2013-12-02

4.7" (CG)

[Go to TOP](#)



Warpage

105.0045

14 CG 厚度

2017-1-17	310 × 128 × 1.1 mm (CG)	Go to TOP
-----------	----------------------------	---------------------------

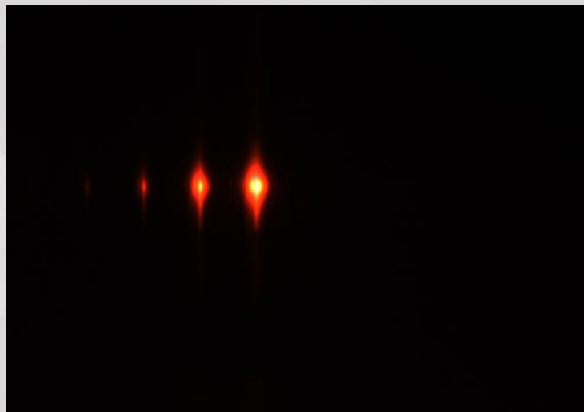

Pixels	Thickness(um)
193	1072

HCC

15 AG Gloss 反射率

2017-1-11

207.96 × 141 × 2 mm
(CG)

[Go to TOP](#)

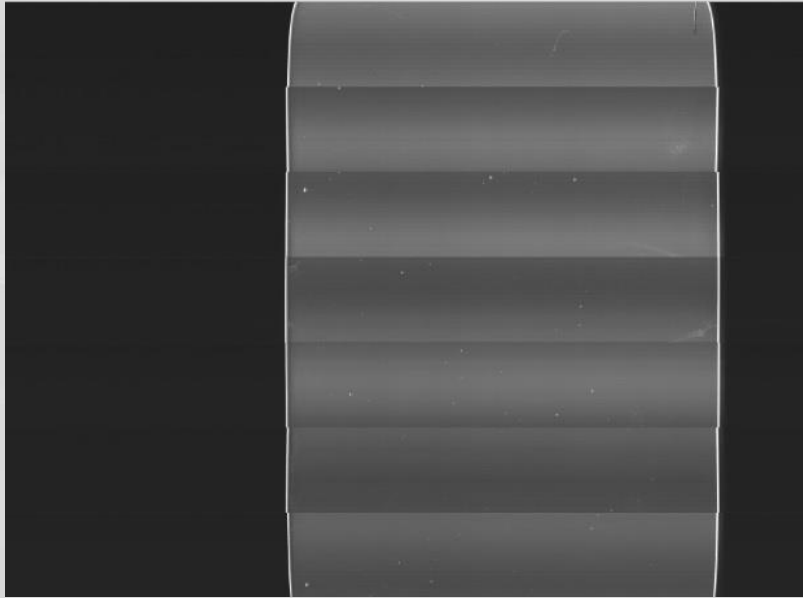

Reflection

102.8188

16 AG 陰影

2016-12-30

195.75 × 154.56 ×
1.1mm (CG)

[Go to TOP](#)

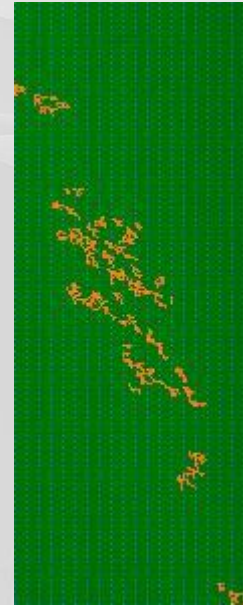

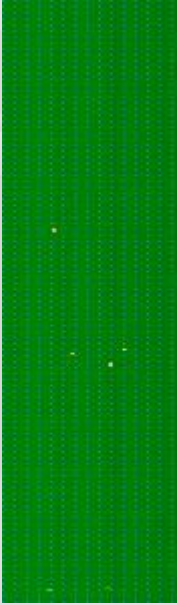

II Cc

17 凹痕(AG)

2016-12-30	195.75 × 154.56 × 1.1mm (CG)	Go to TOP
		

II Cc

18 表層切削(AG)

2016-12-30	195.75 × 154.56 × 1.1mm (CG)	Go to TOP
		

IICc

19 背層切削(AG)

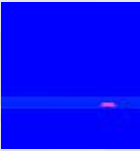
2016-12-30	195.75 × 154.56 × 1.1mm (CG)	Go to TOP
		

IICc

20 刮傷(AG)

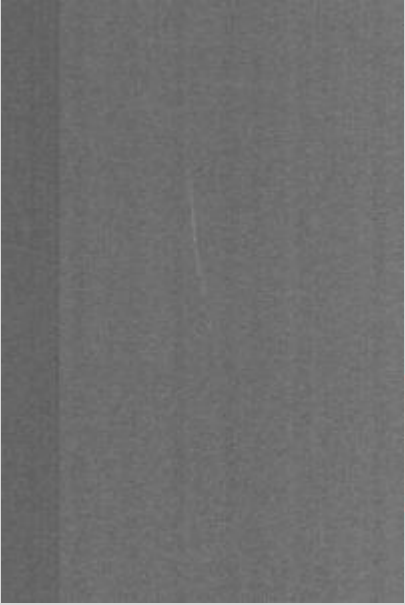
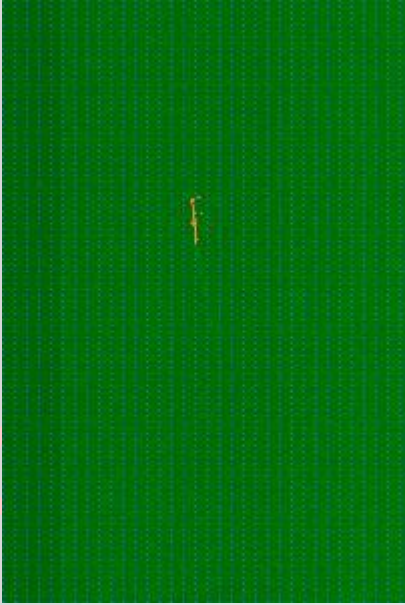
2016-12-7	243.79 × 137.29 × 1.3mm (CG)	Go to TOP
		

21 裂紋(AG)

2017-1-17

207.96 × 141.58 ×
2mm (CG)

[Go to TOP](#)

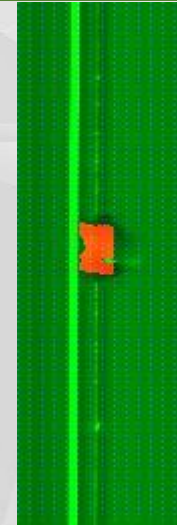
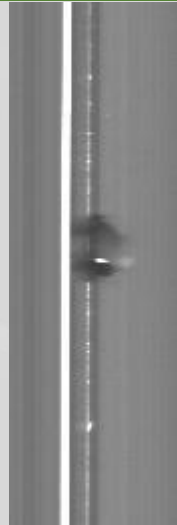

II Cc

22 原材刮傷

2016-10-18	310 × 128 × 1.1mm (CG)	Go to TOP
------------	---------------------------	---------------------------

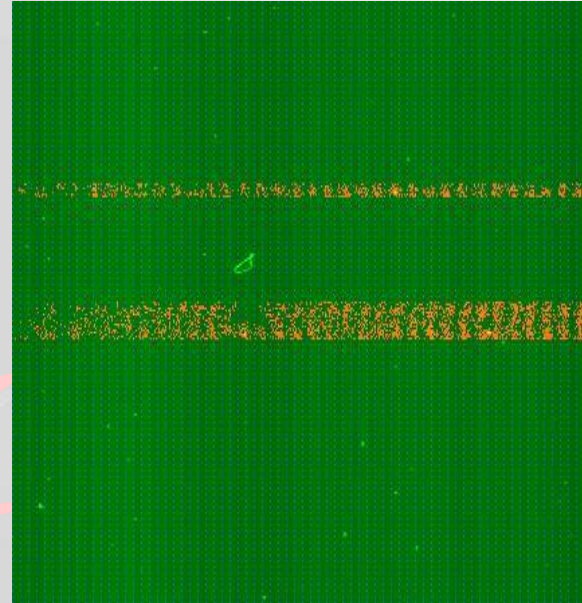
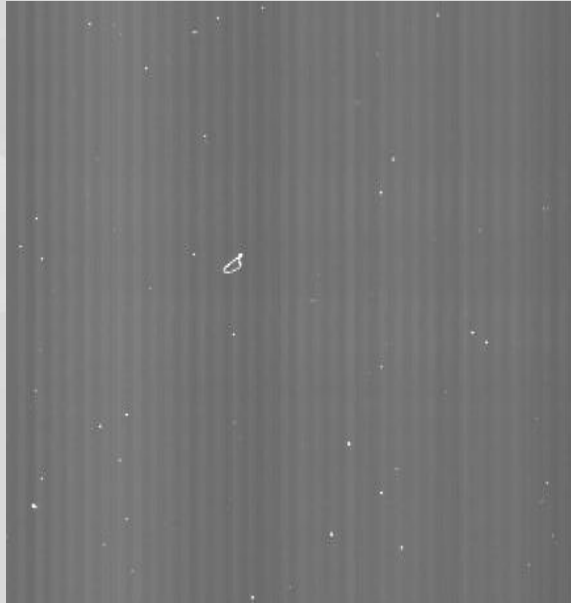

23 點狀不良(AG)

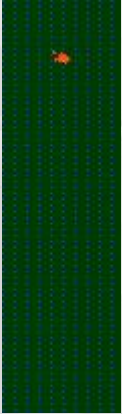
2016-11-25	207.96 × 141.58 × 2mm (CG)	Go to TOP
		

IICc

1 CF 邊破		
2015-7-24	5" (COG)	Go to TOP
		

IICc

2 TFT 邊破

2015-7-24	5" (COG)	Go to TOP
		

II Cc

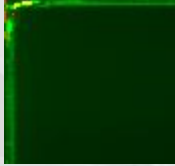
3 CF 角破		
2015-7-24	5" (COG)	Go to TOP
		

IICc

4 TFT 角破

2015-7-24	5" (COG)	Go to TOP
		

IICc

5 裂紋

2015-7-24

5" (COG)

[Go to TOP](#)



IICc

6 銀膠不良

2015-7-24



5" (COG)

[Go to TOP](#)



IICc

7 邊緣凸起

2015-7-24	5" (COG)	Go to TOP
		

IICc

8 膜翹

2015-2-25

5" (COG)

[Go to TOP](#)

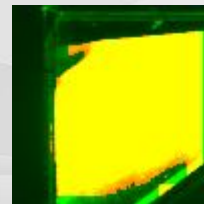

IICc

9 偏光板刮傷

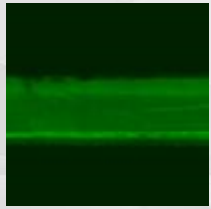
2015-7-8	5" (COG)	Go to TOP
		

IICc

1 蝕刻不良

2016-02-01

1.0" (ITO)

[Go to TOP](#)

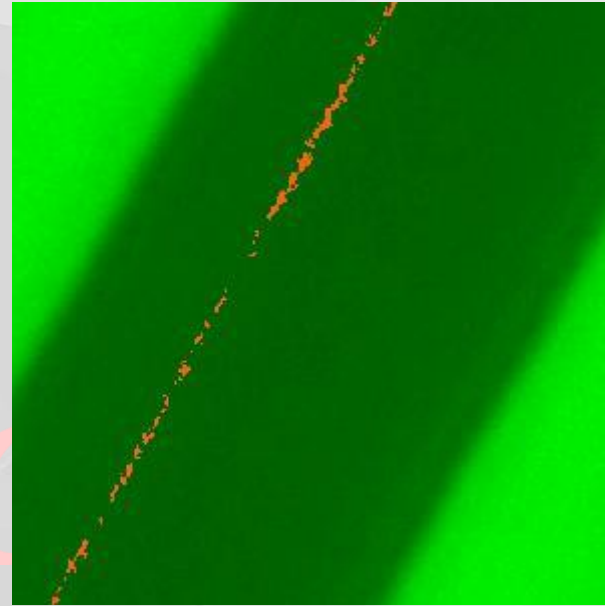
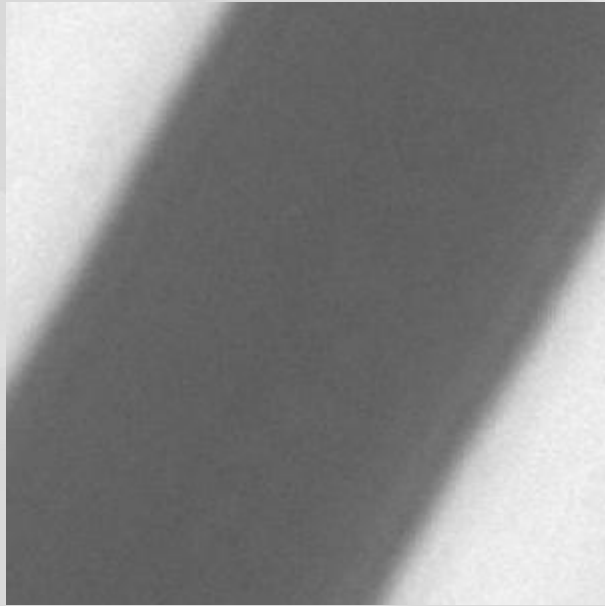

2 蝕刻斷裂



2016-02-01

1.0" (ITO)

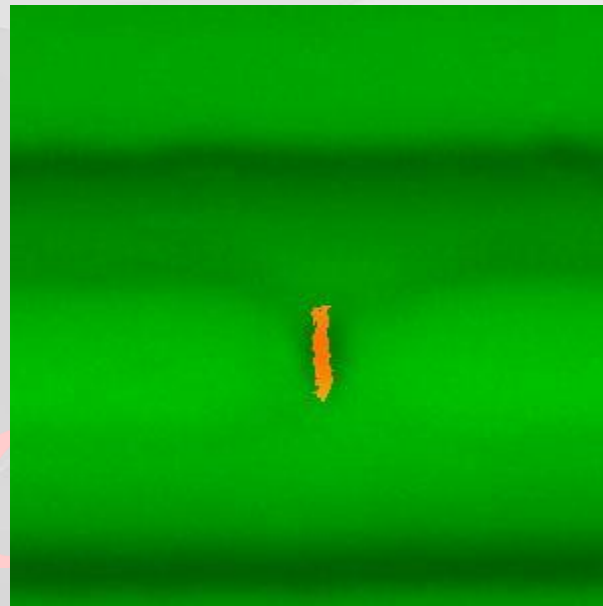
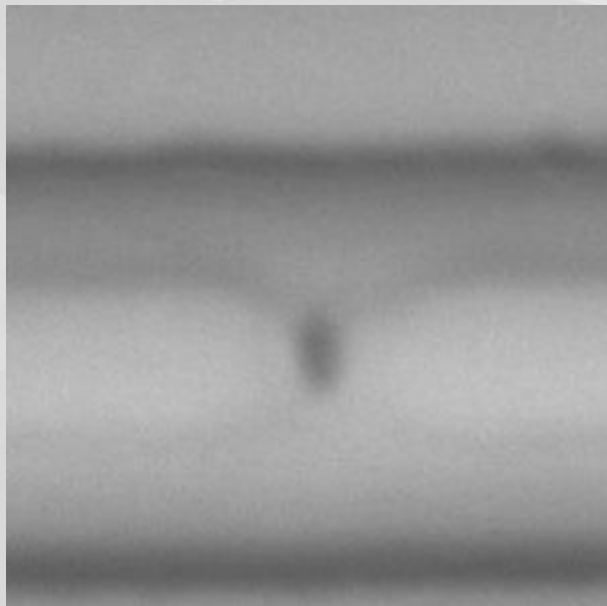
[Go to TOP](#)





1 冷料

2016-7-29	150.5 × 88.7 × 2.6mm (Light Guide Plate)	Go to TOP
		

HCc

2 光點

2016-7-29	150.5 × 88.7 × 2.6mm (Light Guide Plate)	Go to TOP
		

HCc

3 混料

2016-7-29

150.5 × 88.7 × 2.6mm
(Light Guide Plate)

[Go to TOP](#)

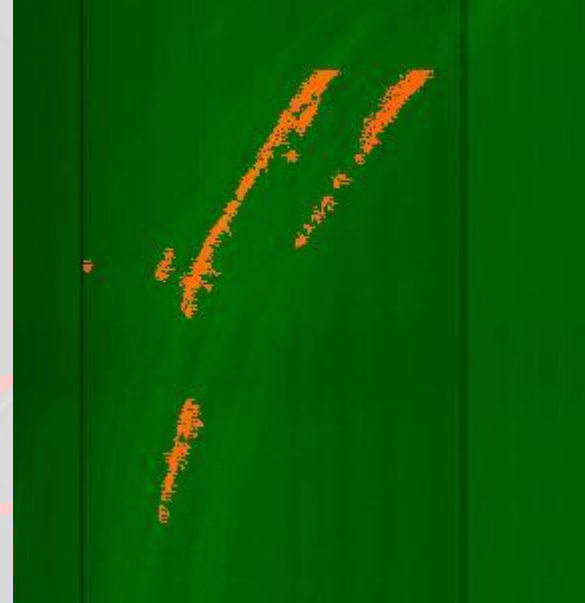

4 暗影

2016-8-1	180.5 × 135.5 × 3.0mm (Light Guide Plate)	Go to TOP
		

IICc

5 摩擦痕

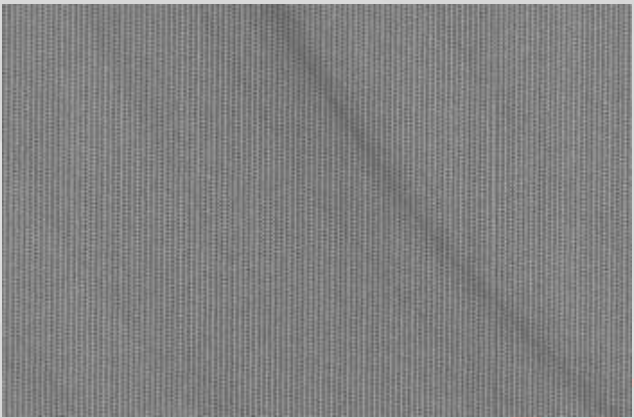
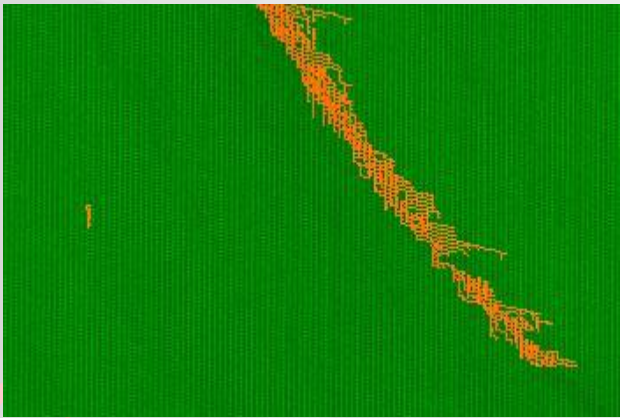
2016-8-1	180.5 × 135.5 × 3.0mm (Light Guide Plate)	Go to TOP
		

ncc

6 噴油

2016-7-29

177.5 × 135.5 × 3.6mm
(Light Guide Plate)

[Go to TOP](#)

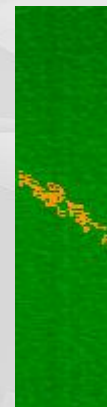

IICc

7 紅點

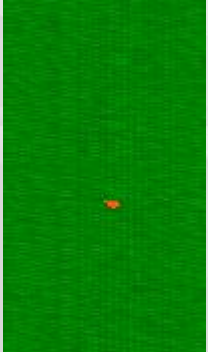
2016-7-29	177.5 × 135.5 × 3.6mm (Light Guide Plate)	Go to TOP
		

HCc

8 黑點

2016-7-29	177.5 × 135.5 × 3.6mm (Light Guide Plate)	Go to TOP
		

IICc

9 暗線

2016-8-1

180.5 × 135.5 × 3.0mm
(Light Guide Plate)

[Go to TOP](#)

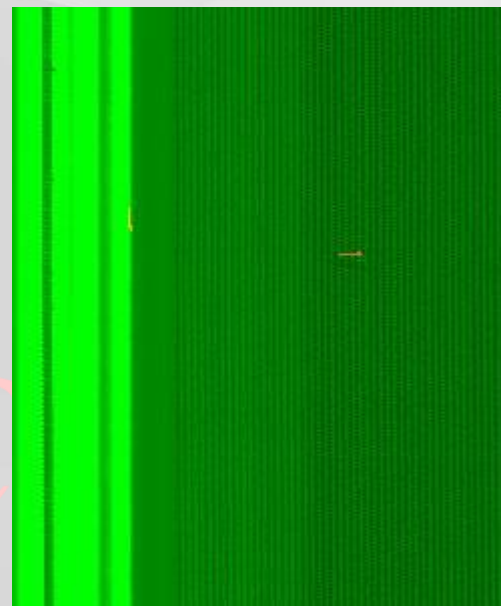
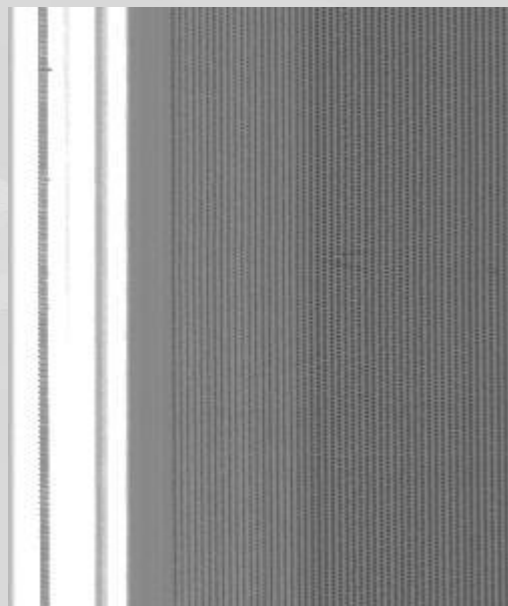

10 卡料

2016-8-1

150.5 × 88.7 × 2.6mm
(Light Guide Plate)

[Go to TOP](#)

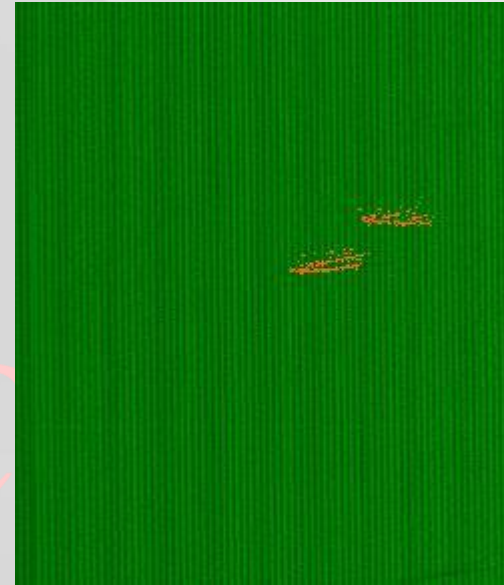
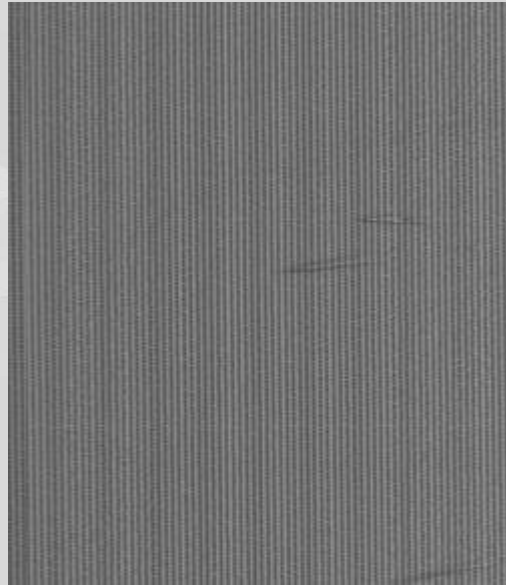

11 異物

2016-8-1	150.5 × 88.7 × 2.6mm (Light Guide Plate)	Go to TOP
		

IICc

12 黄点

2016-8-2	180 × 112 × 0.6mm (Light Guide Plate)	Go to TOP
		

IICc

13 崩角

2016-8-1	353 × 210 × 0.7mm (Light Guide Plate)	Go to TOP
		



IICc

14 牽絲

2016-8-2	160 × 99 × 2.3mm (Light Guide Plate)	Go to TOP
		

HCc

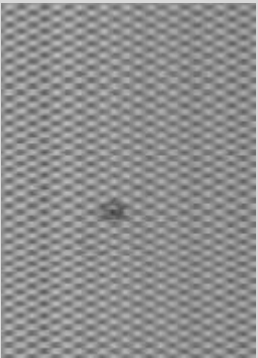
15 氣泡

2016-8-2	228 × 178 × 2.1mm (Light Guide Plate)	Go to TOP
		

HCc

1 劃痕

2015-11-24

5.7" (OLED Panel)

[Go to TOP](#)



IICc

2 印刷不良

2015-11-24

5.7" (OLED Panel)

[Go to TOP](#)



IICc

3 髒汙

2015-11-24

5.7" (OLED Panel)

[Go to TOP](#)

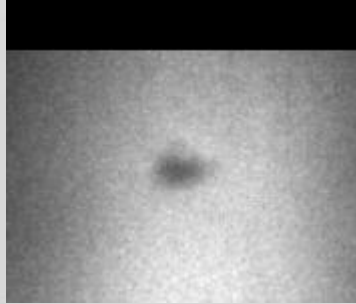

II Cc

4 異物

2015-11-24

5.7" (OLED Panel)

[Go to TOP](#)



II Cc

5 正面邊崩

2015-11-24

5.7" (OLED Panel)

[Go to TOP](#)

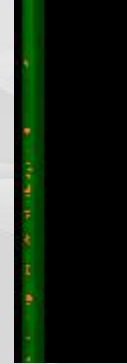
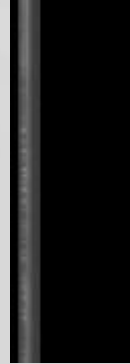

IICc

6 缺藍色保護貼

2015-11-24

5.7" (OLED Panel)

[Go to TOP](#)



II Cc

7 凹點

2015-11-24

5.7" (OLED Panel)

[Go to TOP](#)



II Cc



8 IC 腳缺陷

2015-11-24

5.7" (OLED Panel)

[Go to TOP](#)



IICc

9 溢膠

2015-11-24

5.7" (OLED Panel)

[Go to TOP](#)

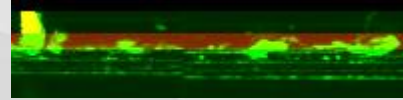

IICc

10 缺紅色保護貼

2015-11-24

5.7" (OLED Panel)

[Go to TOP](#)

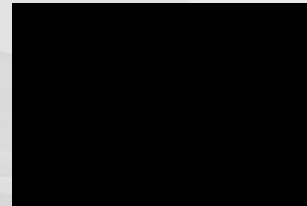

IICc

11 背面邊崩

2015-11-24

5.7" (OLED Panel)

[Go to TOP](#)

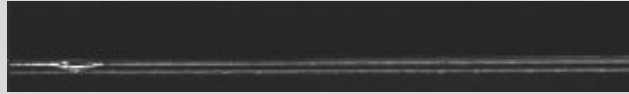

IICc

1 刮傷

2014-7-21

43 × 35mm (LOGO)

[Go to TOP](#)

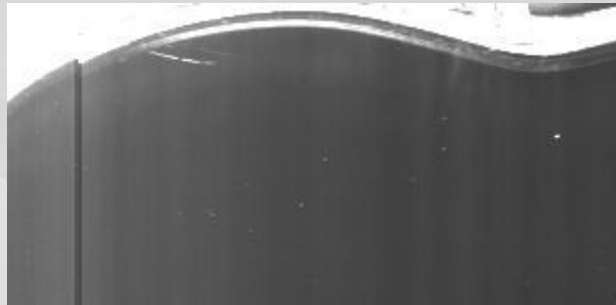

2014-7-21

43 × 35mm (LOGO)

[Go to TOP](#)

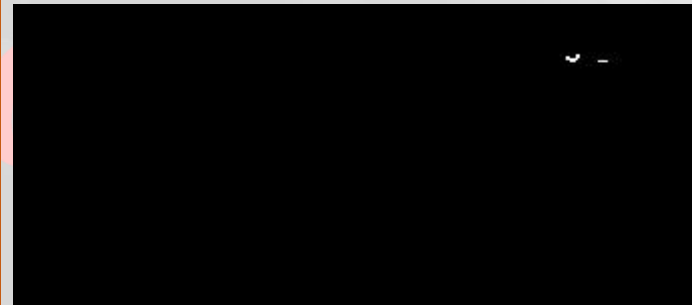
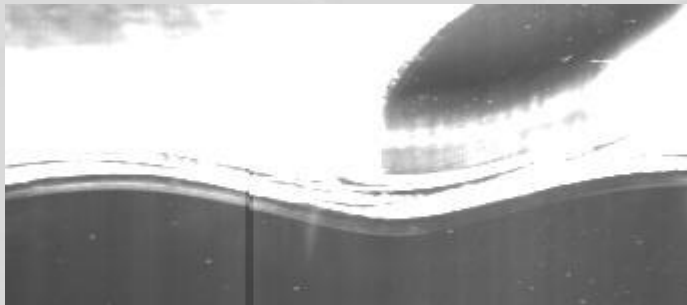







2014-7-21

43 × 35mm (LOGO)

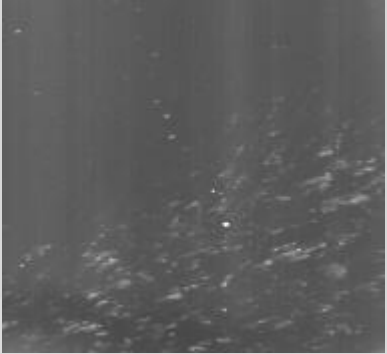
[Go to TOP](#)



2 汚染物

2014-7-22	43 × 35mm (LOGO)	Go to TOP
		
2014-7-22	43 × 35mm (LOGO)	Go to TOP
		
2014-7-22	43 × 35mm (LOGO)	Go to TOP
		

3 條紋

2014-7-23

43 × 35mm (LOGO)

[Go to TOP](#)

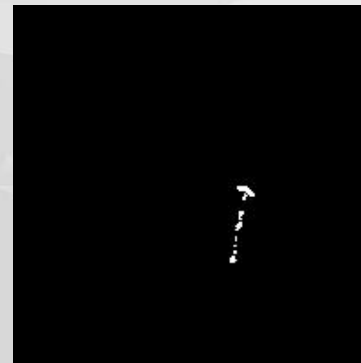
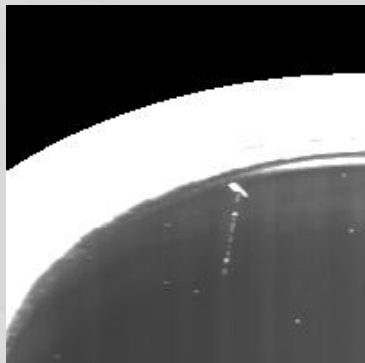

2014-7-23

43 × 35mm (LOGO)

[Go to TOP](#)



2014-7-23

43 × 35mm (LOGO)

[Go to TOP](#)

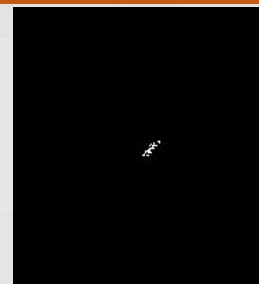

4 針孔

2014-7-24

43 × 35mm (LOGO)

[Go to TOP](#)

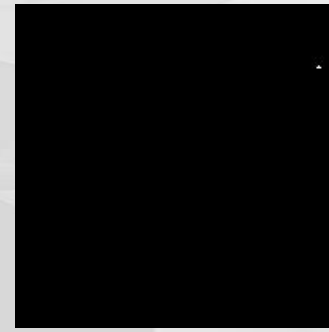

2014-7-24

43 × 35mm (LOGO)

[Go to TOP](#)

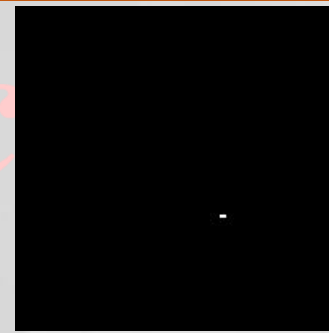
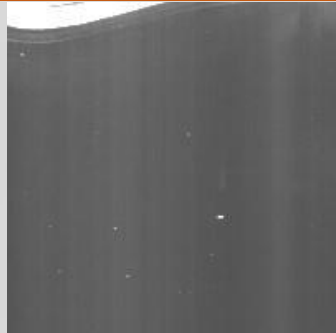

2014-7-24

43 × 35mm (LOGO)

[Go to TOP](#)

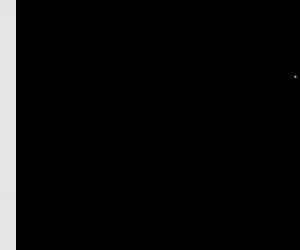

5 糊狀的邊緣

2014-7-5

43 × 35mm (LOGO)

[Go to TOP](#)

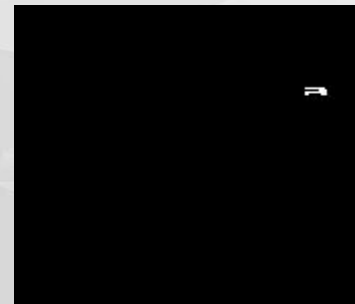
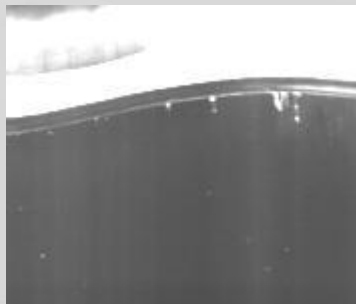

2014-7-5

43 × 35mm (LOGO)

[Go to TOP](#)

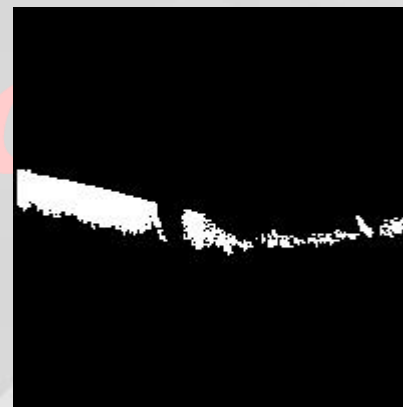
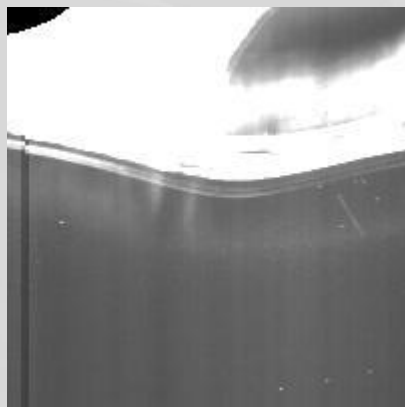

6 鑄斑

2014-7-24

43 × 35mm (LOGO)

[Go to TOP](#)

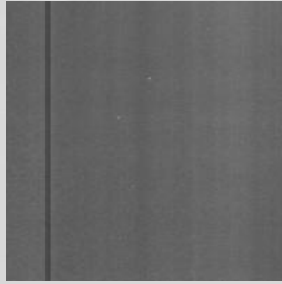

2014-7-24

43 × 35mm (LOGO)

[Go to TOP](#)

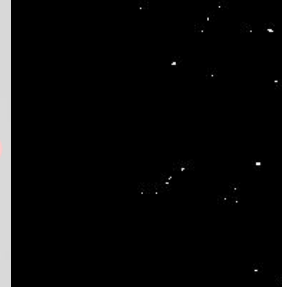
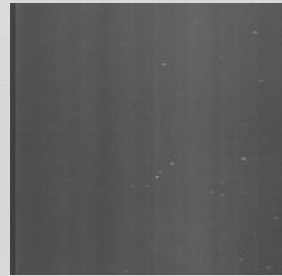

2014-7-24

43 × 35mm (LOGO)

[Go to TOP](#)



7 橘皮

2014-7-25

43 × 35mm (LOGO)

[Go to TOP](#)



2014-7-25

43 × 35mm (LOGO)

[Go to TOP](#)

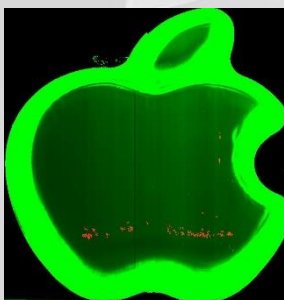

2014-7-25

43 × 35mm (LOGO)

[Go to TOP](#)

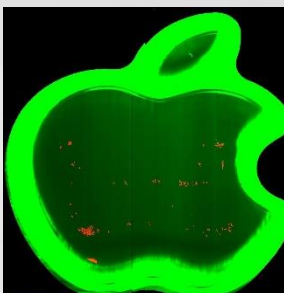

8 凹痕

2014-7-25

43 × 35mm (LOGO)

[Go to TOP](#)

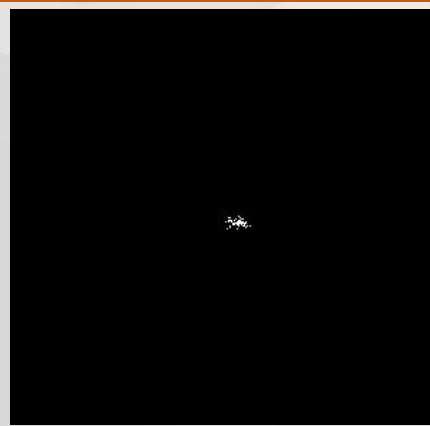
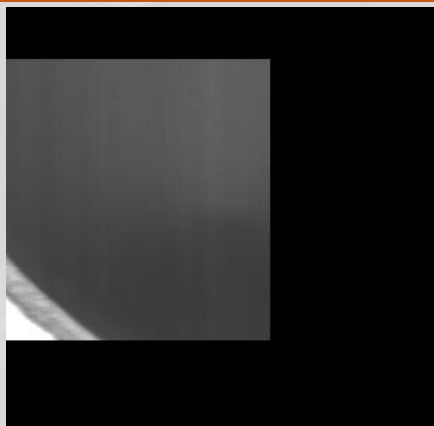

2014-7-25

43 × 35mm (LOGO)

[Go to TOP](#)

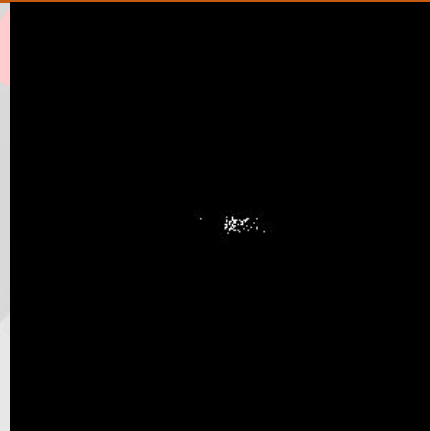
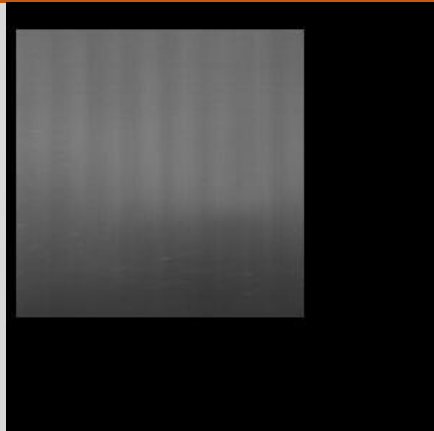

9 Haze 霧度

2014-7-25

43 × 35mm (LOGO)

[Go to TOP](#)

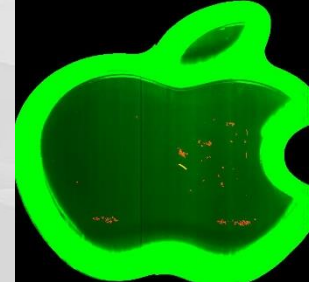
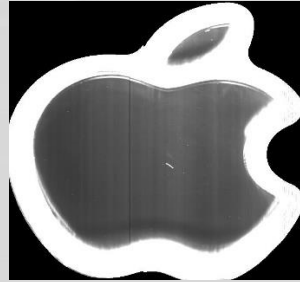

2014-7-25

43 × 35mm (LOGO)

[Go to TOP](#)

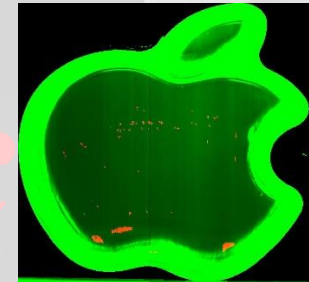

2014-7-25

43 × 35mm (LOGO)

[Go to TOP](#)

